

TYPE 400 GEAR BOX

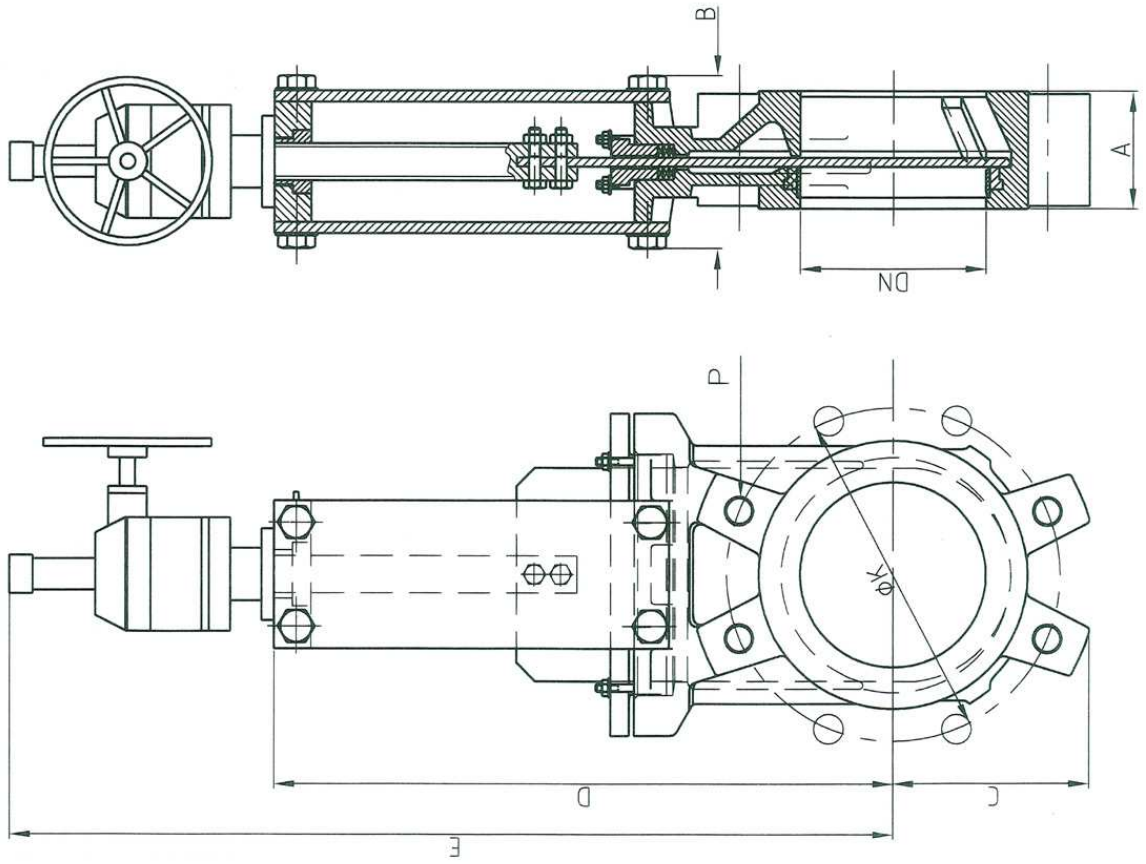

DN	INCHES	A	B	C	D	E
200	8"	89	120	170	522	930
250	10"	114	120	202	625	1130
300	12"	114	120	240	725	1230
350	14"	127	192	255	845	1502
400	16"	140	192	295	945	1607
450	18"	152	192	318	1045	1697
500	20"	152	192	345	1148	1813
600	24"	178	290	405	1360	2148

*Higher diameters under request.

DN	INCHES	Ø K		NO. HOLES	P	
		PN 10	ANSI 150		PN 10	ANSI 150
200	8"	295	298,4	8	M20	W 3/4"
250	10"	350	361,9	12	M20	W 7/8"
300	12"	400	431,8	12	M20	W 7/8"
350	14"	460	476,2	16	M20	W 1"
400	16"	515	539,7	16	M24	W 1"
450	18"	565	577,8	20	M24	W 1 1/8"
500	20"	620	635	20	M24	W 1 1/8"
600	24"	725	749,3	20	M27	W 1 1/4"