

TYPE 400 PNEUMATIC (DOUBLE ACTING)

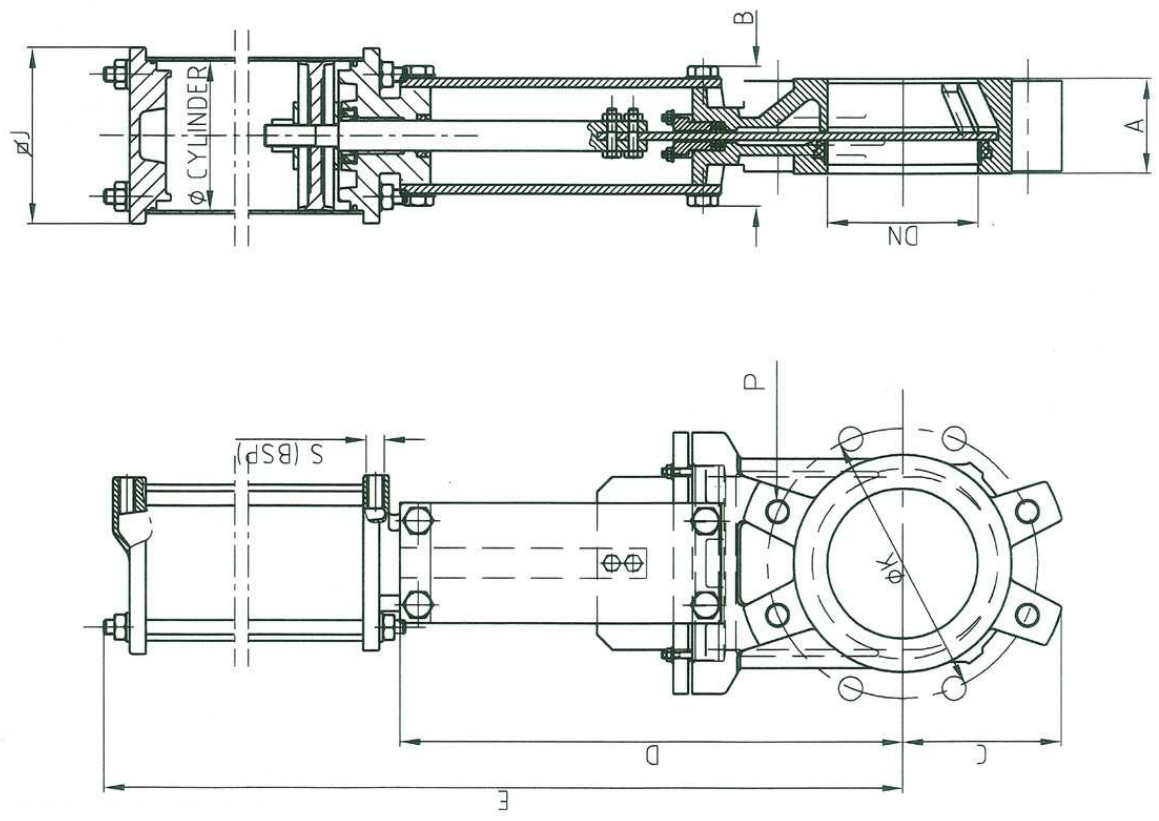

DN	INCHES	A	B	C	D	E	Ø CYLINDER	Ø J	S (B.S.P)
50	2"	60	90	60	240	410	80	96	1/4"
65	2 1/2"	60	90	68	270	456	80	96	1/4"
80	3"	64	90	90	295	500	80	96	1/4"
100	4"	64	90	105	335	560	100	115	1/4"
125	5"	70	100	118	370	640	125	138	1/4"
150	6"	76	100	135	418	716	125	138	1/4"
200	8"	89	120	170	522	880	160	175	1/4"
250	10"	114	120	202	625	1042	200	218	3/8"
300	12"	114	120	240	725	1182	200	218	3/8"
350	14"	127	192	255	845	1360	250	270	3/8"
400	16"	140	192	295	945	1540	250	270	3/8"
450	18"	152	192	318	1045	1675	300	382	1/2"
500	20"	152	192	345	1148	1840	300	382	1/2"
600	24"	178	290	405	1360	2145	300	382	1/2"

*Higher diameters under request.

DN	INCHES	Ø K		NO. HOLES	P	
		PN 10	ANSI 150		PN 10	ANSI 150
50	2"	125	120,6	4	M16	W 5/8"
65	2 1/2"	145	139,7	4	M16	W 5/8"
80	3"	160	152,4	8	M16	W 5/8"
100	4"	180	190,5	8	M16	W 5/8"
125	5"	210	215,9	8	M16	W 3/4"
150	6"	240	241,3	8	M20	W 3/4"
200	8"	295	298,4	8	M20	W 3/4"
250	10"	350	361,9	12	M20	W 7/8"
300	12"	400	431,8	12	M20	W 7/8"
350	14"	460	476,2	16	M20	W 1"
400	16"	515	539,7	16	M24	W 1"
450	18"	565	577,8	20	M24	W 1 1/8"
500	20"	620	635	20	M24	W 1 1/8"
600	24"	725	749,3	20	M27	W 1 1/4"